



SPARE PARTS LIST

LOGIC III

SPARE PARTS

Category: **LOGIC III**

nمبر	article code		unit/calc
2	ELECONALL048	Microswitch for crank, 1 contact NO	price/piece
3	ELESUP311001	Crank support, galvanised 1,5 mm	price/piece
4	ELEDIVALL075	Handle for manual operation	price/piece
5	PDFCELALL016	Wireless receiver for WD (24VAC)	price/piece
6.1	ELETLCALL009	Receiver remote control RXS-K/B ZRG041 433mHz (G41)	price/piece
6.2	ELETLCALL021	Receiver INDUSTRIAL 1 channel T20RX-01 APL (G45)	price/piece
9	ELECOFALL025	Add-on card DYNIII for AIRLOCK or traffic lights, with 5 pins	price/piece
10	ELECOFALL027	Add-on card for D313 brake	price/piece
11	ELECOFALL028	Display	price/piece
12	ELECONALL055	Magnetic loop amplifier (G61)	price/piece
13.1	ELECOFALL029	Keyfoil pad LOGIC III	price/piece
13.2	ELECOFALL030	Keyfoil pad for inox control box LOGIC III	price/piece
14.1	ELECOF313001	LOGIC III blank control box for stock 1x230V	price/piece
14.2	ELECOF313002	LOGIC III blank control box for stock 1x230V - Stainless steel	price/piece
14.3	ELECOFALL032	LOGIC III blank control box for stock 2.2Kw 3x400V - Galvanised steel	price/piece
15.1	PDFCOFALL016	LOGIC III control box (WD, encoder connector and crank incl.) - Galvanised steel	price/piece
15.2	PDFCOFALL017	LOGIC III control box (WD, encoder connector; extension card traffic lights and crank incl.) - Galvanised steel	price/piece
15.3	PDFCOFALL022	LOGIC III control box (WD, encoder connector and crank incl.) - Stainless steel	price/piece
15.4	PDFCOFALL023	LOGIC III control box (WD, encoder connector; extension card traffic lights and crank incl.) - Stainless steel	price/piece
16	PDFCOFALL041	Kit of 3 fuses for LOGIC III 1x230V	price/piece
17	ELEDIVALL089	LOGIC III main switch handle black	price/piece
20	ELEDIVALL090	earthing clamp LOGIC3 (motor cable) TS35 Ref SF/SKL 9-11	price/piece
93	ELEDIVALL012	heating element 8-10W for control box	price/piece

SPARE PARTS

LOGIC III

Add-on card TST_RFUE

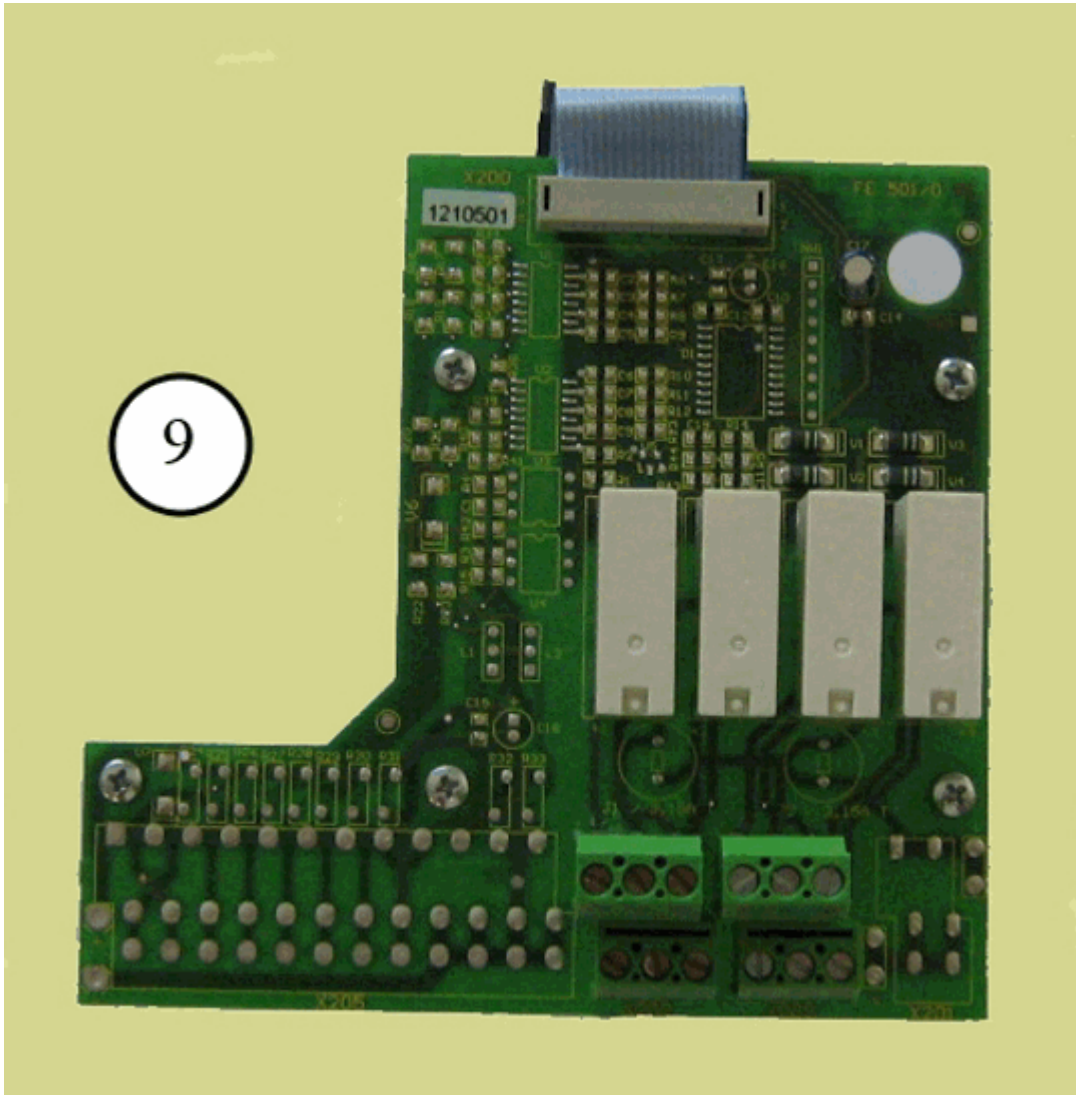

SPARE PARTS

LOGIC III

Add-on card for D313

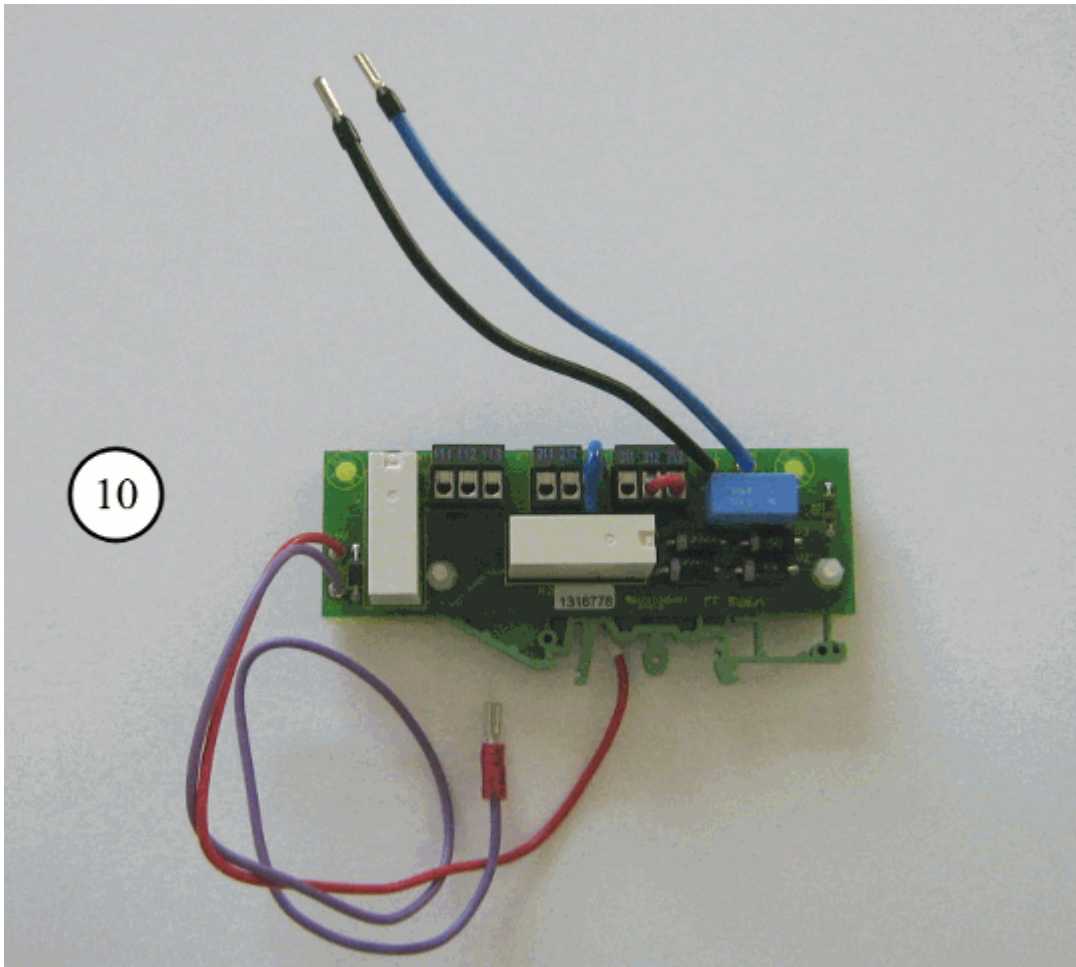

SPARE PARTS

LOGIC III

Display

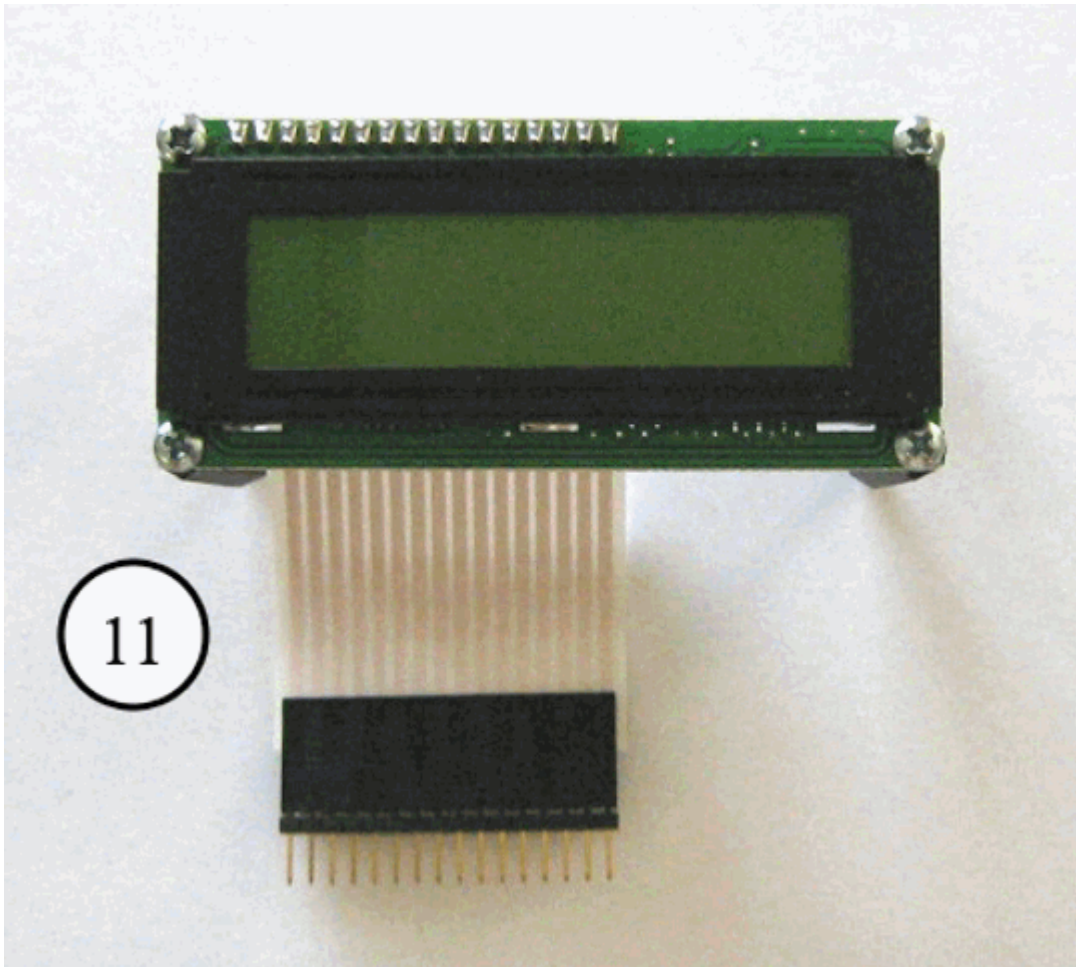

Magnetic loop amplifier

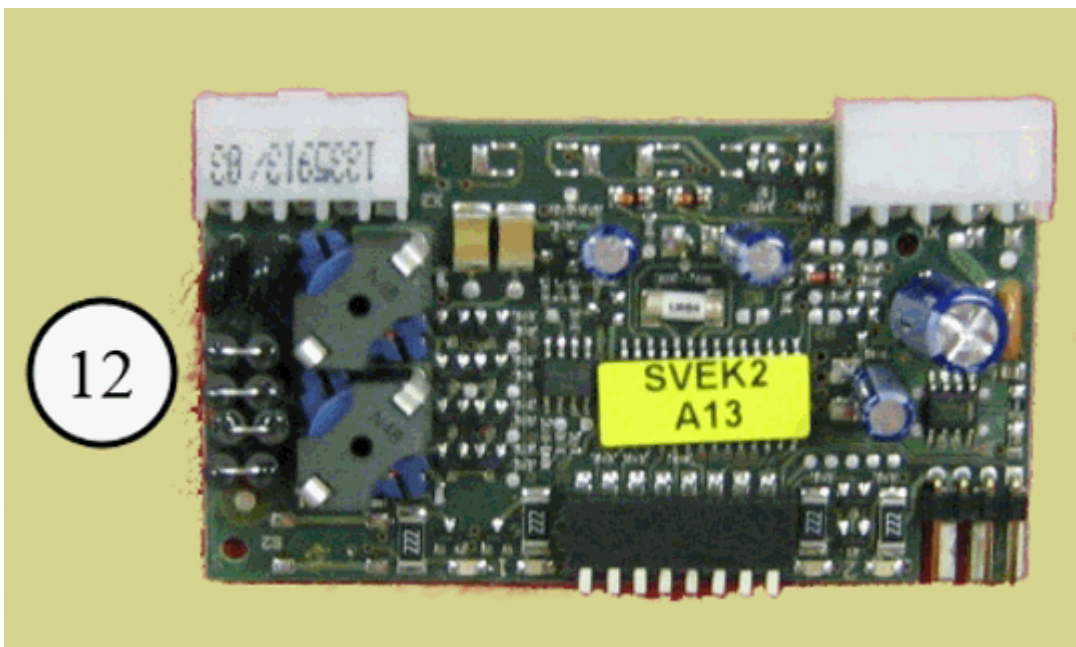

SPARE PARTS

LOGIC III

Controlbox



14

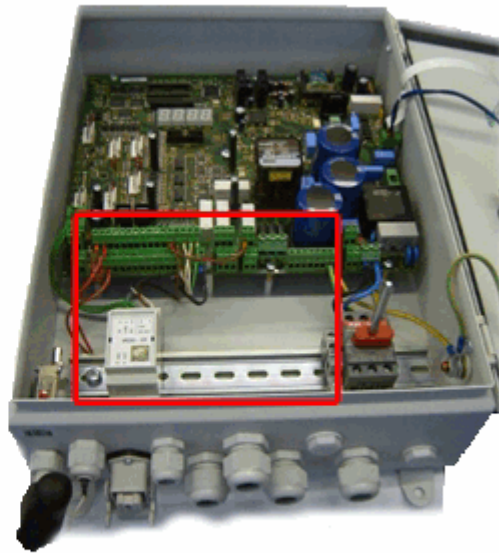

15

Switch LOGIC III



17

SPARE PARTS

LOGIC III

keyfoil pad

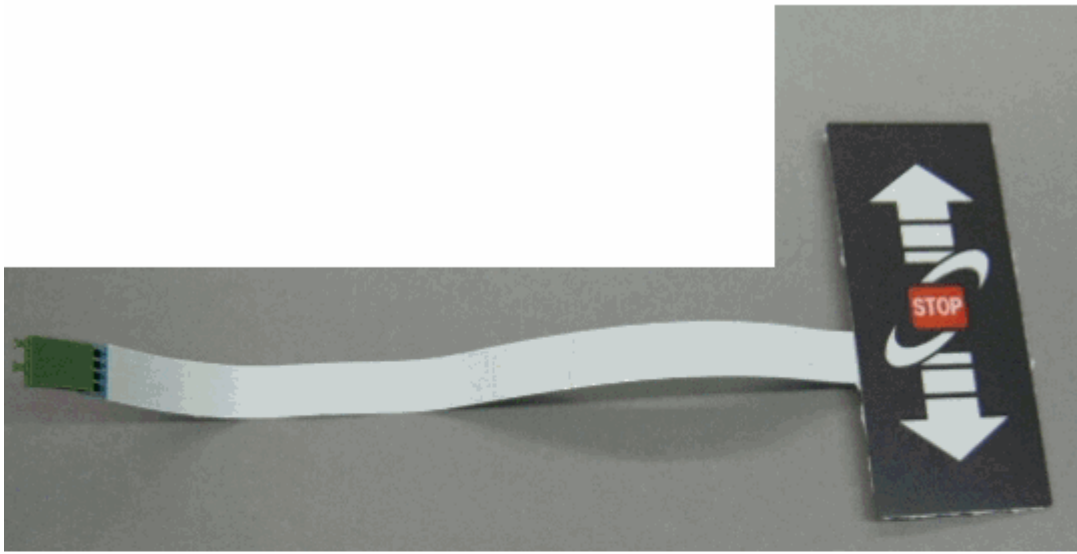

13



SPARE PARTS

LOGIC III

control box parts V2

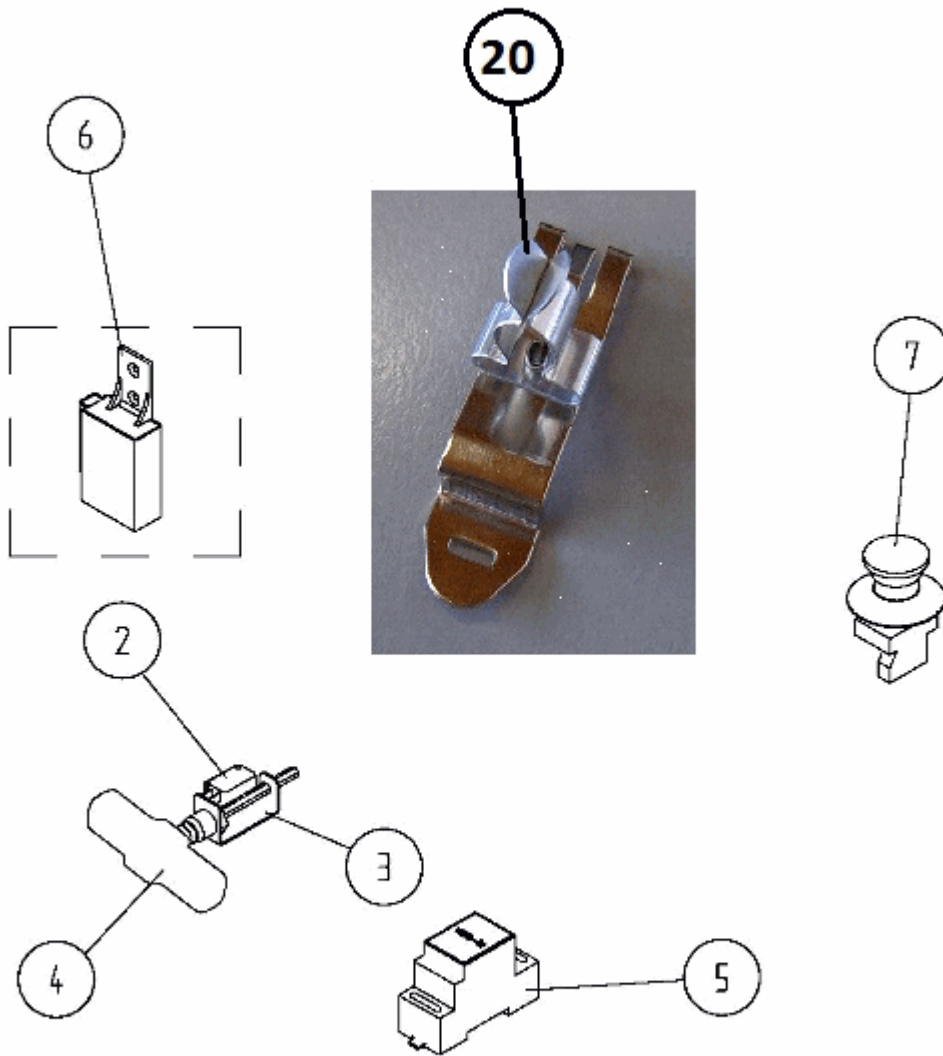

SPARE PARTS

LOGIC III

FREEZER V1

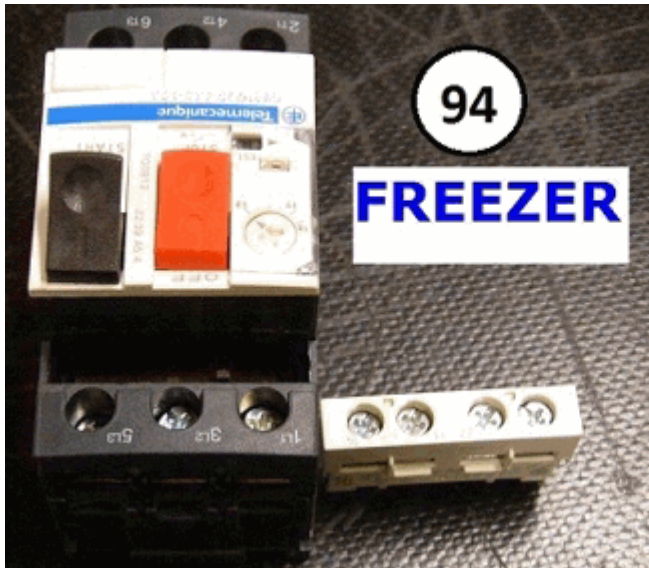

Fuses LOGIC3 1x230V

